



Leading In....

LED Lighting





Golden Temple



OLIVE L.E.D.
The light you can trust.
An ISO 9001:2008 Certified Company

OLIVE-OVERVIEW

Founded in the year 1994, Olive is a market-leading LED light manufacturing and exporting company in India providing sustainable lighting solutions for indoor and outdoor. Empowering life with innovative, qualitative and cost-effective lighting solutions has been our business philosophy, and our strong commitment to quality has fetched us the coveted ISO 9001:2008 certification.

We bring in a wide assortment of lighting products like for diverse residential, commercial and industrial uses. All our products have proven credibility to consume less power and they also have very long service life. Apart from manufacturing & supplying LED lighting systems, we also provide with supportive accessories like Casing, MCPCB, Drivers and offer OEM services.

OUR INFRASTRUCTURE

Olive's excellence in LED lighting sector begins with a robust infrastructure. We have in place two state-of-the-art factories of 450 sq. mtrs each with installed capacity of 5000 PCS, a prudent team of R&D and quality experts, industry's best manpower, and a well organized supply and service chain.

Our manufacturing units are outfitted with the latest machineries and tools, including CAD/CAM for design, LED sensors, LED analyzer, ICT, ATE and much other instrumentation that make the high-end infrastructure for LED lighting production.

We also boast of a sophisticated research cell where intensive research and development activities are undertaken by our specialized team of R&D experts for product improvement in line with global market trends.

Employing the best technology available, the A-grade raw material sourced from all over the world, and investing heavily in R&D, we have invented and patented a series of products. Our lighting products are powered with considerable features like low heat & fire risk, power saving of over 70% and consistent operation even in the most unfavorable condition.

We skillfully combine price and quality and offer our clients true value for money. This is the reason top-tier names both in domestic and overseas market including Bosch, Honda Siel, Indian Oil Company, NDMC, Indian Railway and many others of similar stature rely on the brand value of Olive to meet their extensive lighting needs.

Further, we have a high-tech packaging unit, wherein packing of all our products is done using industry recommended materials under strict supervision of experts and in consonance with exact requirements of our esteemed clients.

With our up-to-date infrastructure we remain ready to customize products according to market demand. This also enables us to produce export quality products and meet the client's bulk requirements at a short notice and with the confidence of clients.



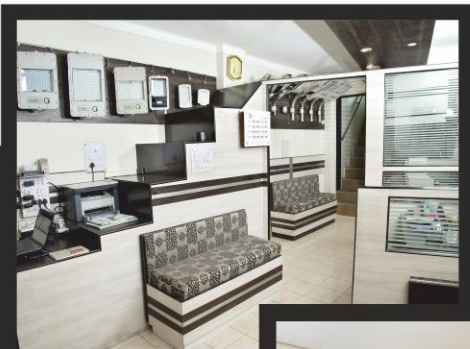
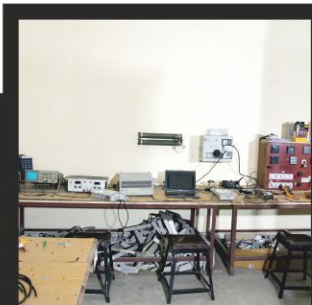

OLIVE'S ACHIEVEMENTS

We have more than 10 patents into the domain of LED lighting for which we have got certification from Government of India and many other accrediting agencies of global stature. Presently, we have over 25 products on our profile, and lately we have filed application to get patent for a revolutionary LED light that has potential to save the power load up to 98% for some specific uses.

We are one of the biggest manufacturers in India for LED lighting product and one among the chosen few companies in India that have earned coveted Carbon Credit for our innovative and eco-friendly products.

As we follow a well thought-out quality management program - through which we systematically monitor and objectively evaluate the quality, efficiency and effectiveness of our products and services, we have been accorded ISO 9001:2008 certification.

Our products remain the best choice in industry for having unmatched electrical specification and delivering the highest performance. This has made us stand atop in the field of LED lighting products.

CERTIFICATION AND CREDENTIALS

- * AN ISO 9001:2008 CERTIFIED COMPANY
- * SSI, MSME, NSIC APPROVED COMPANY
- * R&D, MANUFACTURING AND TESTING FACILITIES AT DELHI & HARYANA
- * PATENT CERTIFICATES FOR INNOVATED LED PRODUCTS
- * COMPANY HAVING INFRASTRUCTURE & FACILITIES AS PER BIS STANDARDS
- * DGS&D ENLISTMENT FOR ALL INDOOR & OUTDOOR LED PRODUCTS
- * MNRE APPROVED PRODUCTS MANUFACTURING COMPANY
- * BIS, CE, FCC & RoHS APPROVED PRODUCTS
- * OEM FOR BIG LIGHT MANUFACTURER GROUPS IN INDIA
- * REGISTERED WITH BEE AS ESCO
- * EMPANELLED WITH EESL FOR SUPPLY OF INDOOR, OUTDOOR AND SOLAR LIGHTING SYSTEMS
- * MANUFACTURING AS PER RDSO STANDARDS & PRODUCTS INSPECTED BY RITES
- * APPROVED VENDOR FOR BHARAT PETROLEUM CORPORATION LIMITED (BPCL)
- * APPROVED SUPPLIER FOR MINISTRY OF DEFENCE AND INDIAN NAVY
- * REGISTERED VENDOR IN INDIAN RAILWAYS, DMRC AND CHHITTARANJAN LOCOMOTIVE WORKS
- * ENERGY SERVICE COMPANY REGISTERED.
- * CUSTOMISATION FACILITIES FOR ALL INDOOR AND OUTDOOR LED LIGHTING
- * CERTIFIED BY NSIC-ONICRA CREDIT RATING AGENCY OF INDIA LTD
- * LM-79 CERTIFIED PRODUCTS FROM NABL ACCREDITED LABORATORIES.
- * APPROVED VENDOR FOR NTPC, BHEL, BPCL, MUMBAI PORT TRUST, SMVDSB, ITI, DMRC, IIT, DMRC, SE COALFIELD, CRPF, RAILWAYS, EMBASSY OF UNITED STATE OF AMERICA, HCL, BAHAI HOUSE (LOTUS TEMPLE), GOLDEN TEMPLE, DOORDARASHAN/PRASAR BHARTI, NFL, HCL, THDC, NHDC, MARUTI, AND MANY MORE GOVERNMENT DEPARTMENTS.
- * SOME OF OUR CLIENTS IN CORPORATE WORLD : GODREJ, JINDAL POWER LTD, BGR ENERGY, KHAITAN, DD MOTORS, JP, L&T AND MANY MORE.





LED : BRIGHT LIGHT FOR SUSTAINABILITY

It's a scientifically proven fact that LED bulbs use 90% less electricity than other bulbs. An Led light bulb can last you up to 100,000 hours compared to 8,000 for compact fluorescent and 1,000 for an incandescent. That averages out to 12 hours of light per day for 12 years.

The best way to conserve energy is to use less of it. And LED bulbs are perfect fit in this regard. LED light bulbs are directional - that means they only put the light where you aim it or where you need it. Incandescent bulbs and most of the compact fluorescent bulb, on the other hand, just sit there and throw their glow all over the place - wasting electricity and generating much heat towards global warming.

SALIENT FEATURES & ADVANTAGES OF OLIVE LIGHTS

1. 100% safety and efficacy of our LED Light Fixtures.
2. Maximum lumen output per watt in comparison to all other light sources.
3. Minimum lumen depreciation over a period of time.
4. Lifespan of approx. 50,000 hrs. (With L-70 factor)
5. Reduction in maintenance cost-
 - a) Our products are warranted for up to 5 Years.
 - b) Zero Investment on Inventory.
 - c) Reduced repair & maintenance expenses, i.e. less frequent use of Crane and or Man-power.
6. High-performance LED Lights with:
 - a) Timer, LDR, Astronomical control & dimming as well as other smart devices.
 - b) Specialized protection devices to enhance life & performance.
7. Consistent operation from 90V to 290V.
8. State-of-the-art Stylish & ergonomic designs.
9. Proven technology in a cost effective package.
10. No risk of exposure to Mercury in the event of breakage.
11. No Hazardous waste disposal concerns.
12. Earn Carbon credit (Less Green House Emission).
13. MADE IN INDIA Product for total peace of mind.
14. Short Pay-back period - Return on investment period is less than a year in some cases.

Replacement Of Incandescent Lamp With LED Garland Light.:



Break even points with in 9 months

- Electricity bill
- Low Maintaince
- Not Fusable
- Salary of labor
- Extra stock
- Breakage
- Installation





LED Decorative Garland Light

•This Decorative Garland light has attached wire with the length as per the requirement of Customer. We be offering Customized LED lighting products and services, we make sure that we utilize A-grade raw materials such as HEAT SINK, LEDs, MC PCBs, DRIVERS, WIRES AND OTHER ACCESSORIES for product designing and development. These raw materials are sourced from reliable partners across the world, and strictly inspected and quality tested by experts prior to incorporation into the manufacturing process.

Advantages of LED decorative garland light

- Energy efficient
- Long life
- One time investment
- High voltage protection
- Over heat protection
- Over current protection
- Surge protection
- Short circuit protection
- Not breakable



Silent Features of Eco Friendly Pendant light :-

- Unique Design
- Shock absorber top mount
- High pressure aluminium body
- Toughened Glass /poly carbonate
- Wide operating voltage range 90V-290V AC
- ON/OFF Indicators
- Flameproof
- Low Power consumption
- Instant-on, Flicker free
- Better Colour Rendering for security Cameras
- Over - Heat protection
- Customisation welcome.



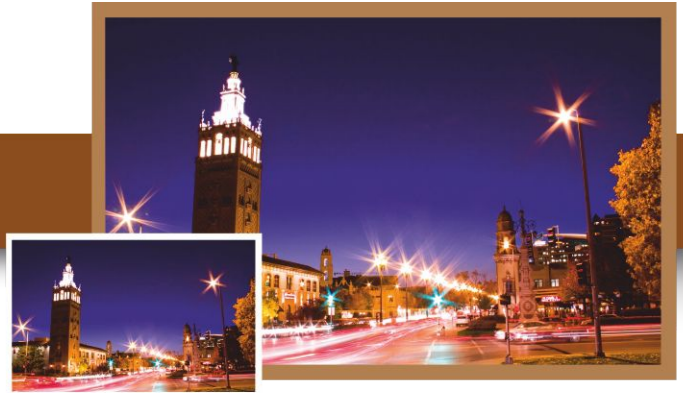

LED Street Light

Product No :- SLOL-10

Power	9, 12, 18, 24 Watts
Input Voltage	12V DC, 24/48/110V AC/DC, 230V AC
PF	>0.95
CCT	2800K-6500K (Optional)
CRI	>80Ra
Angle/Optics	120° and 60/120° (Optional)
LED Lumens	145/watts
THD	<10%
Mounting	ϕ 37 mm

For More Details Please refer Product Specifications Online



Product No :- SLOL-10 Pre

Power	24, 36 Watts
Input Voltage	12V DC, 24/48/110V AC/DC, 230V AC
PF	>0.95
CCT	2800K-6500K (Optional)
CRI	>80Ra
Angle/Optics	120° and 60/120° (Optional)
LED Lumens	145/watts
THD	<10%
Mounting	ϕ 40 mm

For More Details Please refer Product Specifications Online



Product No :- SLOL-15

Power	24, 36 Watts
Input Voltage	12V DC, 24/48/110V AC/DC, 230V AC
PF	>0.95
CCT	2800K-6500K (Optional)
CRI	>80Ra
Angle/Optics	120° and 60/120° (Optional)
LED Lumens	145/watts
THD	<10%
Mounting	ϕ 25-40 mm

For More Details Please refer Product Specifications Online



Product No :- SLOL-10-20

Power	24, 36 Watts
Input Voltage	12V DC, 24/48/110V AC/DC, 230V AC
PF	>0.95
CCT	2800K-6500K (Optional)
CRI	>80Ra
Angle/Optics	120° and 60/120° (Optional)
LED Lumens	145/watts
THD	<10%
Mounting	ϕ 25-40 mm

For More Details Please refer Product Specifications Online

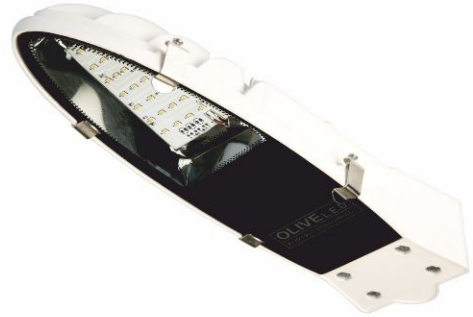

Product No :- SLOL-20

Power	24, 36, 45 Watts
Input Voltage	12V DC, 24/48/110V AC/DC, 230V AC
PF	>0.95
CCT	2800K-6500K (Optional)
CRI	>80Ra
Angle/Optics	120° and 60/120° (Optional)
LED Lumens	145/watts
THD	<10%
Mounting	ϕ 37 mm

For More Details Please refer Product Specifications Online



Product No :- SLOL-30

Power	36, 50, 65 Watts
Input Voltage	12V DC, 24/48/110V AC/DC, 230V AC
PF	>0.95
CCT	2800K-6500K (Optional)
CRI	>80Ra
Angle/Optics	120° and 60/120° (Optional)
LED Lumens	145/watts
THD	<10%
Mounting	ϕ 40 mm

For More Details Please refer Product Specifications Online





Product No :- Long Light

Power	24, 36, 45 Watts
Input Voltage	12V DC, 24/48/110V AC/DC, 230V AC
PF	>0.95
CCT	2800K-6500K (Optional)
CRI	>80Ra
Angle/Optics	120° and 60/120° (Optional)
LED Lumens	145/watts
THD	<10%
Mounting	φ 25-40 mm

For More Details Please refer Product Specifications Online



Product No :- Rocket With PC

Power	24, 36, 45 Watts
Input Voltage	12V DC, 24/48/110V AC/DC, 230V AC
PF	>0.95
CCT	2800K-6500K (Optional)
CRI	>80Ra
Angle/Optics	120° and 60/120° (Optional)
LED Lumens	145/watts
THD	<10%
Mounting	φ 25-40 mm

For More Details Please refer Product Specifications Online



Product No :- Retrofit Street light

Power	24, 36, 60 Watts
Input Voltage	12V DC, 24/48/110V AC/DC, 230V AC
PF	>0.95
CCT	2800K-6500K (Optional)
CRI	>80Ra
Angle/Optics	120° and 60/120° (Optional)
LED Lumens	145/watts
THD	<10%
Base	E27/B22

For More Details Please refer Product Specifications Online



Product No :- SLOL-15-30

Power	36, 45, 55, 65, 75 Watts
Input Voltage	12V DC, 24/48/110V AC/DC, 230V AC
PF	>0.95
CCT	2800K-6500K (Optional)
CRI	>80Ra
Angle/Optics	120° and 60/120° (Optional)
LED Lumens	145/watts
THD	<10%
Mounting	ϕ 50 mm

For More Details Please refer Product Specifications Online



Product No :- SLOL-60

Power	36, 45, 55, 65, 75, Watts
Input Voltage	12V DC, 24/48/110V AC/DC, 230V AC
PF	>0.95
CCT	2800K-6500K (Optional)
CRI	>80Ra
Angle/Optics	120° and 60/120° (Optional)
LED Lumens	145/watts
THD	<10%
Weight	2.5 Kg
Mounting	ϕ 50 mm

For More Details Please refer Product Specifications Online



Product No :- SLOL-40-60

Power	36, 45, 55, 65, 75, 90 Watts
Input Voltage	12V DC, 24/48/110V AC/DC, 230V AC
PF	>0.95
CCT	2800K-6500K (Optional)
CRI	>80Ra
Angle/Optics	120° and 60/120° (Optional)
LED Lumens	145/watts
THD	<10%
Mounting	ϕ 25-40 mm

For More Details Please refer Product Specifications Online



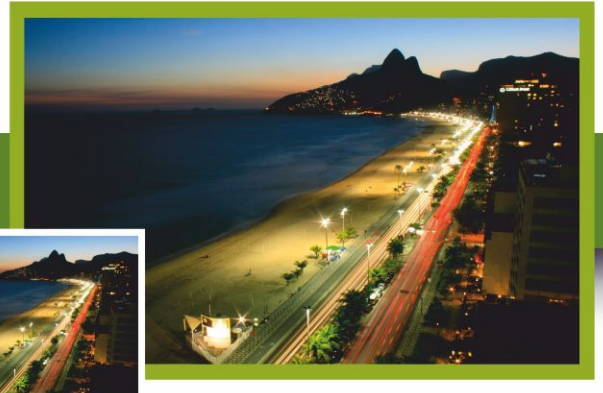

Product No :- SLOL-50

Power	65, 80, 100, Watts
Input Voltage	12V DC, 24/48/110V AC/DC, 230V AC
PF	>0.95
CCT	2800K-6500K (Optional)
CRI	>80Ra
Angle/Optics	120° and 60/120° (Optional)
LED Lumens	145/watts
THD	<10%
Mounting	ϕ 60 mm

For More Details Please refer Product Specifications Online



Product No :- SLOL-70

Power	80, 100, 120, 150 Watts
Input Voltage	12V DC, 24/48/110V AC/DC, 230V AC
PF	>0.95
CCT	2800K-6500K (Optional)
CRI	>80Ra
Angle/Optics	120° and 60/120° (Optional)
LED Lumens	145/watts
THD	<10%
Mounting	ϕ 60 mm

For More Details Please refer Product Specifications Online



Product No :- SLOL-50-100

Power	100, 125, 150, 200 Watts
Input Voltage	12V DC, 24/48/110V AC/DC, 230V AC
PF	>0.95
CCT	2800K-6500K (Optional)
CRI	>80Ra
Angle/Optics	120° and 60/120° (Optional)
LED Lumens	145/watts
THD	<10%
Mounting	ϕ 60 mm

For More Details Please refer Product Specifications Online



Product No :- SLOL-100-150

Power	190, 200, 237, 250 Watts
Input Voltage	12V DC, 24/48/110V AC/DC, 230V AC
PF	>0.95
CCT	2800K-6500K (Optional)
CRI	>80Ra
Angle/Optics	120° and 60/120° (Optional)
LED Lumens	145/watts
THD	<10%
Mounting	φ60 mm

For More Details Please refer Product Specifications Online



Product No :- SLOL-150-200

Power	200, 250, 300 Watts
Input Voltage	12V DC, 24/48/110V AC/DC, 230V AC
PF	>0.95
CCT	2800K-6500K (Optional)
CRI	>80Ra
Angle/Optics	120° and 60/120° (Optional)
LED Lumens	145/watts
THD	<10%
Mounting	φ60 mm

For More Details Please refer Product Specifications Online



Product No :- SLOL-300

Power	200, 250, 300 Watts
Input Voltage	12V DC, 24/48/110V AC/DC, 230V AC
PF	>0.95
CCT	2800K-6500K (Optional)
CRI	>80Ra
Angle/Optics	120° and 60/120° (Optional)
LED Lumens	145/watts
THD	<10%
Mounting	φ60 mm

For More Details Please refer Product Specifications Online

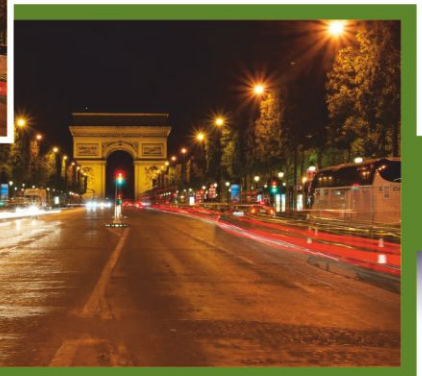



Product No :- SLOLCOBSS

Power	35, 45, Watts
Input Voltage	12V DC, 24/48/110V AC/DC, 230V AC
PF	>0.95
CCT	2800K-6500K (Optional)
CRI	>80Ra
Angle/Optics	120° and 60/120° (Optional)
LED Lumens	145/watts
THD	<10%
Mounting	ϕ 50 mm

For More Details Please refer Product Specifications Online



Product No :- SLOLCOBSL

Power	50, 65, 75 Watts
Input Voltage	12V DC, 24/48/110V AC/DC, 230V AC
PF	>0.95
CCT	2800K-6500K (Optional)
CRI	>80Ra
Angle/Optics	120° and 60/120° (Optional)
LED Lumens	145/watts
THD	<10%
Mounting	ϕ 50 mm

For More Details Please refer Product Specifications Online



Product No :- SLOLCOBD

Power	80, 100, 120 Watts
Input Voltage	12V DC, 24/48/110V AC/DC, 230V AC
PF	>0.95
CCT	2800K-6500K (Optional)
CRI	>80Ra
Angle/Optics	120° and 60/120° (Optional)
LED Lumens	145/watts
THD	<10%
Mounting	ϕ 50 mm

For More Details Please refer Product Specifications Online



LED Bay Lights

Product No :- SBOL-50

Power	35, 45, 65 watts
Input Voltage	12V DC, 24/48/110V AC/DC, 230V AC
PF	>0.95
CCT	2800K-6500K (Optional)
CRI	>80Ra
Angle/Optics	120°
LED Lumens	145/watts
THD	<10%
Mounting	C/U Clamp

For More Details Please refer Product Specifications Online



Product No :- MBOL-100

Power	75, 100, 125, 150 watts
Input Voltage	12V DC, 24/48/110V AC/DC, 230V AC
PF	>0.95
CCT	2800K-6500K (Optional)
CRI	>80Ra
Angle/Optics	120° and 60/120° (Optional)
LED Lumens	145/watts
THD	<10%
Mounting	C/U Clamp

For More Details Please refer Product Specifications Online



Product No :- HBOL-200

Power	125, 150, 200, 250 watts
Input Voltage	12V DC, 24/48/110V AC/DC, 230V AC
PF	>0.95
CCT	2800K-6500K (Optional)
CRI	>80Ra
Angle/Optics	120° and 60/120° (Optional)
LED Lumens	145/watts
THD	<10%
Mounting	C/U Clamp

For More Details Please refer Product Specifications Online



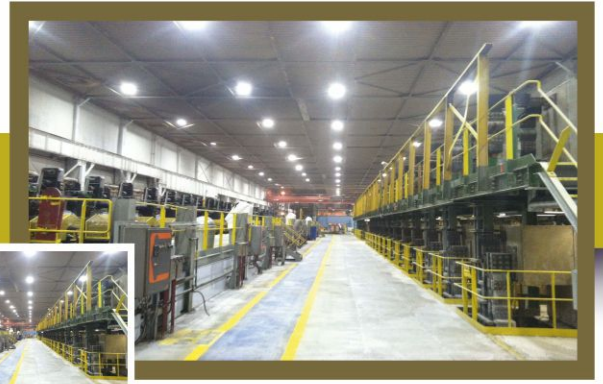

LED Flame Proof Lights

Product No :- PENDENT LIGHT

Power	10, 20, 30, 40 watts
Input Voltage	12V DC, 24/48/110V AC/DC, 230V AC
PF	>0.95
CCT	2800K-6500K (Optional)
CRI	>80Ra
Angle/Optics	120°
LED Lumens	145/watts
THD	<10%
Mounting	C/U Clamp

For More Details Please refer Product Specifications Online



Product No : FLP1

Power	35, 45, 60 Watts
Input Voltage	12V DC, 24/48/110V AC/DC, 230V AC
PF	>0.95
CCT	2800K-6500K (Optional)
CRI	>80Ra
Angle/Optics	180°
LED Lumens	145/watts
THD	<10%
Mounting	1 bolt

For More Details Please refer Product Specifications Online



Product No : FLP2

Power	35, 45, 60 Watts
Input Voltage	12V DC, 24/48/110V AC/DC, 230V AC
PF	>0.95
CCT	2800K-6500K (Optional)
CRI	>80Ra
Angle/Optics	180°
LED Lumens	145/watts
THD	<10%
Mounting	1 bolt

For More Details Please refer Product Specifications Online



Product No :- FLAME PROOF BULK HEAD

Power	36, 45, 65, 80, 100 Watts
Input Voltage	12V DC, 24/48/110V AC/DC, 230V AC
PF	>0.95
CCT	2800K-6500K (Optional)
CRI	>80Ra
Angle/Optics	120° and 60/120° (Optional)
LED Lumens	145/watts
THD	<10%
Mounting	C/U Clamp

For More Details Please refer Product Specifications Online



Product No :- FLAME PROOF TUBE LIGHT

Power	9X2, 18X2 Watts
Input Voltage	12V DC, 24/48/110V AC/DC, 230V AC
PF	>0.95
CCT	2800K-6500K (Optional)
CRI	>80Ra
Angle/Optics	120° and 60/120° (Optional)
LED Lumens	145/watts
THD	<10%
Mounting	C/U Clamp

For More Details Please refer Product Specifications Online



Product No :- LED Flame Proof Torch

Power	3 Watts
Input Voltage	12V DC, 24/48/110V AC/DC, 230V AC
PF	>0.95
CCT	2800K-6500K (Optional)
CRI	>80Ra
Angle/Optics	120° and 60/120° (Optional)
LED Lumens	145/watts
THD	<10%
Mounting	Portable

For More Details Please refer Product Specifications Online





LED Flood Lights

Product No :- Electra Micro

Power	10, 15, 20 Watts
Input Voltage	12V DC, 24/48/110V AC/DC, 230V AC
PF	>0.95
CCT	2800K-6500K (Optional)
CRI	>80Ra
Angle/Optics	120° and 60/120° (Optional)
LED Lumens	145/watts
THD	<10%
Mounting	C/U Clamp

For More Details Please refer Product Specifications Online



Product No :- BLOL-15

Power	24, 36 Watts
Input Voltage	12V DC, 24/48/110V AC/DC, 230V AC
PF	>0.95
CCT	2800K-6500K (Optional)
CRI	>80Ra
Angle/Optics	120° and 60/120° (Optional)
LED Lumens	145/watts
THD	<10%
Mounting	C/U Clamp

For More Details Please refer Product Specifications Online



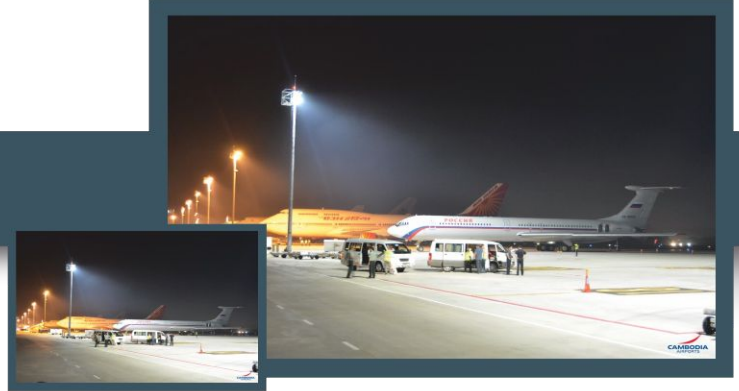

Product No :- Electra Mini

Power	35, 50, 60 Watts
Input Voltage	12V DC, 24/48/110V AC/DC, 230V AC
PF	>0.95
CCT	2800K-6500K (Optional)
CRI	>80Ra
Angle/Optics	120° and 60/120° (Optional)
LED Lumens	145/watts
THD	<10%
Mounting	C/U Clamp

For More Details Please refer Product Specifications Online



Product No :- BLOL-30

Power	36, 45, 55, 65 Watts
Input Voltage	12V DC, 24/48/110V AC/DC, 230V AC
PF	>0.95
CCT	2800K-6500K (Optional)
CRI	>80Ra
Angle/Optics	120° and 60/120° (Optional)
LED Lumens	145/watts
THD	<10%
Mounting	C/U Clamp

For More Details Please refer Product Specifications Online



Product No :- Electra Medium

Power	40, 50, 65, 80, 100, 120, 150 Watts
Input Voltage	12V DC, 24/48/110V AC/DC, 230V AC
PF	>0.95
CCT	2800K-6500K (Optional)
CRI	>80Ra
Angle/Optics	120° and 60/120° (Optional)
LED Lumens	145/watts
THD	<10%
Mounting	C/U Clamp

For More Details Please refer Product Specifications Online





Product No :- BLOL-40-60

Power	36, 45, 55, 65, 75, 90, 100 Watts
Input Voltage	12V DC, 24/48/110V AC/DC, 230V AC
PF	>0.95
CCT	2800K-6500K (Optional)
CRI	>80Ra
Angle/Optics	120° and 60/120° (Optional)
LED Lumens	145/watts
THD	<10%
Mounting	C/U Clamp

For More Details Please refer Product Specifications Online



Product No :- BLOL-50-100

Power	100, 125, 150, 200 Watts
Input Voltage	12V DC, 24/48/110V AC/DC, 230V AC
PF	>0.95
CCT	2800K-6500K (Optional)
CRI	>80Ra
Angle/Optics	120° and 60/120° (Optional)
LED Lumens	145/watts
THD	<10%
Mounting	C/U Clamp

For More Details Please refer Product Specifications Online





Product No :- BLOL-100-150

Power	190, 200, 237, 250 Watts
Input Voltage	12V DC, 24/48/110V AC/DC, 230V AC
PF	>0.95
CCT	2800K-6500K (Optional)
CRI	>80Ra
Angle/Optics	120° and 60/120° (Optional)
LED Lumens	145/watts
THD	<10%
Mounting	C/U Clamp

For More Details Please refer Product Specifications Online



Product No :- BLOL-150-200

Power	200, 250, 300 Watts
Input Voltage	12V DC, 24/48/110V AC/DC, 230V AC
PF	>0.95
CCT	2800K-6500K (Optional)
CRI	>80Ra
Angle/Optics	120° and 60/120° (Optional)
LED Lumens	145/watts
THD	<10%
Mounting	C/U Clamp

For More Details Please refer Product Specifications Online





LED Commercial Light

Product No : 1x1 Ceiling

Power	15, 25, 30, 35 Watts
Input Voltage	12V DC, 24/48/110V AC/DC, 230V AC
PF	>0.95
CCT	2800K-6500K (Optional)
CRI	>80Ra
Angle/Optics	120°
LED Lumens	145/watts
THD	<15%
Mounting	Ceiling / Surface

For More Details Please refer Product Specifications Online



Product No : 2x2 Ceiling

Power	30, 40, 50 Watts
Input Voltage	12V DC, 24/48/110V AC/DC, 230V AC
PF	>0.95
CCT	2800K-6500K (Optional)
CRI	>80Ra
Angle/Optics	120°
LED Lumens	145/watts
THD	<15%
Mounting	Ceiling / Surface

For More Details Please refer Product Specifications Online



Product No : 1x2 Ceiling

Power	30, 40, 50 Watts
Input Voltage	12V DC, 24/48/110V AC/DC, 230V AC
PF	>0.95
CCT	2800K-6500K (Optional)
CRI	>80Ra
Angle/Optics	120°
LED Lumens	145/watts
THD	<15%
Mounting	Ceiling / Surface

For More Details Please refer Product Specifications Online

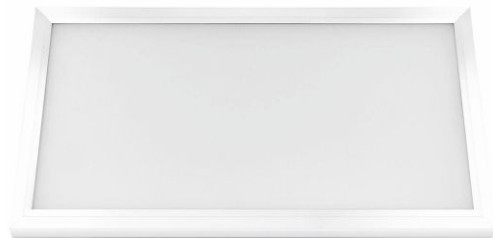

Product No : 1x4 Ceiling

Power	30, 40, 50 Watts
Input Voltage	12V DC, 24/48/110V AC/DC, 230V AC
PF	>0.95
CCT	2800K-6500K (Optional)
CRI	>80Ra
Angle/Optics	120°
LED Lumens	145/watts
THD	<15%
Mounting	Ceiling / Surface

For More Details Please refer [Product Specifications Online](#)



Product No : Canopy

Power	50, 60, 70, 90 Watts
Input Voltage	12V DC, 24/48/110V AC/DC, 230V AC
PF	>0.95
CCT	2800K-6500K (Optional)
CRI	>80Ra
Angle/Optics	120°
LED Lumens	145/watts
THD	<15%
Mounting	Ceiling

For More Details Please refer [Product Specifications Online](#)



Product No : Jet Proof Fitting

Power	20, 40 Watts
Input Voltage	12V DC, 24/48/110V AC/DC, 230V AC
PF	>0.95
CCT	2800K-6500K (Optional)
CRI	>80Ra
Angle/Optics	120°
LED Lumens	145/watts
THD	<15%
Mounting	Surface

For More Details Please refer [Product Specifications Online](#)





LED Architectural Light

Product No : Spick light

Power	6, 9, 12 Watts
Input Voltage	12V DC, 24/48/110V AC/DC, 230V AC
PF	>0.95
CCT	2800K-6500K (Optional)
CRI	>80Ra
Angle/Optics	90°
LED Lumens	145/watts
THD	<15%
Mounting	Ground

For More Details Please refer Product Specifications Online



Product No : Track light

Power	10, 20, 30, 50 Watts
Input Voltage	12V DC, 24/48/110V AC/DC, 230V AC
PF	>0.95
CCT	2800K-6500K (Optional)
CRI	>80Ra
Angle/Optics	90°
LED Lumens	145/watts
THD	<15%
Mounting	Tracks

For More Details Please refer Product Specifications Online



Product No : Up Down Lighter

Power	6, 12, 18 Watts
Input Voltage	12V DC, 24/48/110V AC/DC, 230V AC
PF	>0.95
CCT	2800K-6500K (Optional)
CRI	>80Ra
Angle/Optics	180°
LED Lumens	145/watts
THD	<15%
Mounting	Wall Mounting

For More Details Please refer Product Specifications Online



Product No : Wall Washer

Power	As per Customer Requirements
Input Voltage	12V DC, 24/48/110V AC/DC, 230V AC
PF	>0.95
CCT	2800K-6500K (Optional)
CRI	>80Ra
Angle/Optics	90°
LED Lumens	145/watts
THD	<15%
Mounting	C/U Clamps

For More Details Please refer Product Specifications Online



Product No : Post Top

Power	24, 36, 48 Watts
Input Voltage	12V DC, 24/48/110V AC/DC, 230V AC
PF	>0.95
CCT	2800K-6500K (Optional)
CRI	>80Ra
Angle/Optics	180°
LED Lumens	145/watts
THD	<15%
Mounting	Pole / Gate / Gardens

For More Details Please refer Product Specifications Online



Product No : Bollard

Power	6, 9, 12 Watts
Input Voltage	12V DC, 24/48/110V AC/DC, 230V AC
PF	>0.95
CCT	2800K-6500K (Optional)
CRI	>80Ra
Angle/Optics	180°
LED Lumens	145/watts
THD	<15%
Mounting	Ground

For More Details Please refer Product Specifications Online

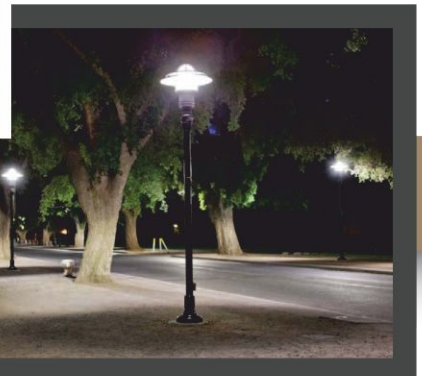



LED Indoor Light

Product No : LED Bulb

Power	3, 5, 7, 9, 12 Watts
Input Voltage	12V DC, 24/48/110V AC/DC, 230V AC
PF	>0.95
CCT	2800K-6500K (Optional)
CRI	>80Ra
Angle/Optics	180°
LED Lumens	145/watts
THD	<15%
Mounting	E27/E14/B22

For More Details Please refer Product Specifications Online



Product No : LED Tube light T8

Power	9, 18 Watts
Input Voltage	12V DC, 24/48/110V AC/DC, 230V AC
PF	>0.95
CCT	2800K-6500K (Optional)
CRI	>80Ra
Angle/Optics	180°
LED Lumens	145/watts
THD	<15%
Mounting	Wall Mounting C/U Clamps

For More Details Please refer Product Specifications Online



Product No : LED Down Light

Power	6, 9, 12, 18, 24 watts
Input Voltage	12V DC, 24/48/110V AC/DC, 230V AC
PF	>0.95
CCT	2800K-6500K (Optional)
CRI	>80Ra
Angle/Optics	120°
LED Lumens	145/watts
THD	<15%
Mounting	Ceiling

For More Details Please refer Product Specifications Online



Product No : LED Surface Light

Power	6, 9, 12, 18, 24, 35, 50 watts
Input Voltage	12V DC, 24/48/110V AC/DC, 230V AC
PF	>0.95
CCT	2800K-6500K (Optional)
CRI	>80Ra
Angle/Optics	120°
LED Lumens	145/watts
THD	<15%
Mounting	Ceiling

For More Details Please refer Product Specifications Online

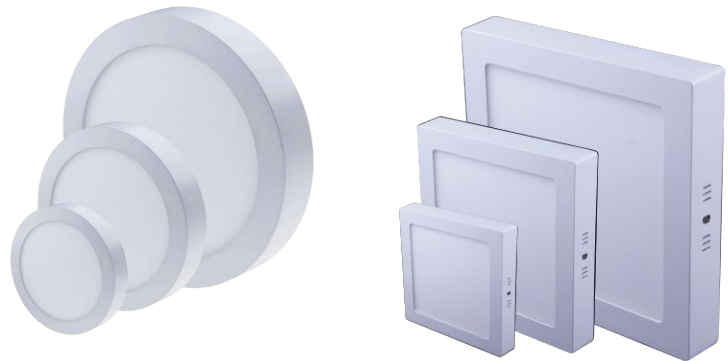

Product No : LED PLL

Power	9, 18 Watts
Input Voltage	12V DC, 24/48/110V AC/DC, 230V AC
PF	>0.95
CCT	2800K-6500K (Optional)
CRI	>80Ra
Angle/Optics	180°
LED Lumens	145/watts
THD	<15%
Mounting	In Existing fixture

For More Details Please refer Product Specifications Online



Product No : LED Strip Light

Power	4.8, 7 watts/ Meter
Input Voltage	12V DC, 24/48/110V AC/DC, 230V AC
PF	>0.95
CCT	2800K-6500K (Optional)
CRI	>80Ra
Angle/Optics	120°
LED Lumens	145/watts
THD	<15%
Mounting	Ceiling

For More Details Please refer Product Specifications Online





LED Retrofit Kit

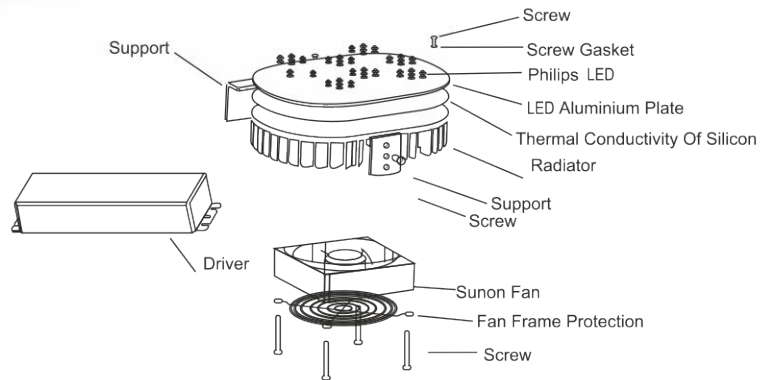
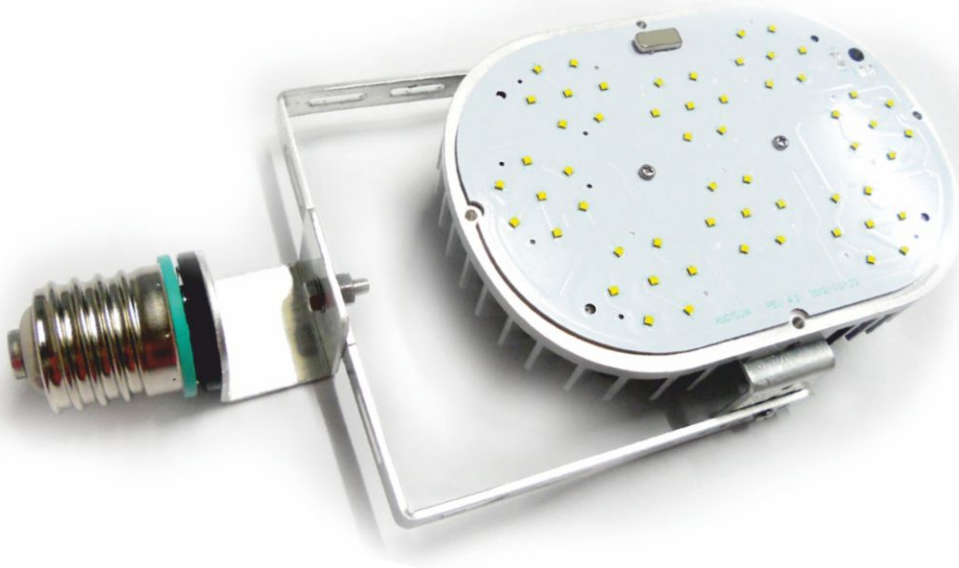

Product Feature

- Excellent Thermal Management;
- Over temperature protection ;
- One Size for more power option;
- Easy to install and connect;
- Suitable for all the traditional lights and fixtures;
- Directly replacing HPS/MHD light source;
- Oval, easy to install and replace;
- Utilizing same lighting fixture , saving investment cost.

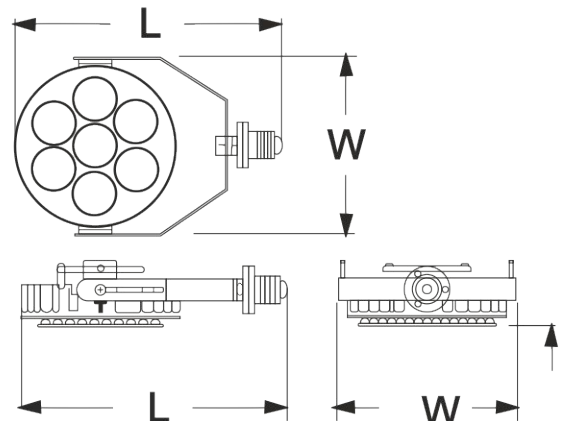

LED Solar Street light with inbuilt Lithium-ion battery.

OLIVE LED is India's best and most-innovative solar street lighting system. It has in-built lithium-ion battery and Battery Management System which makes the installation and maintenance very easy. It is especially crafted to give 30-50% more brightness as compared to other outdoor lighting systems and functions even during cloudy days. The installation and maintenance is very cheap and quick because it is an all-in-one system.

Ordinary street lights need to have a battery box to store heavy LA (wet batteries). It makes the installation process complicated owing to the It can run for 13 hours after getting charged.

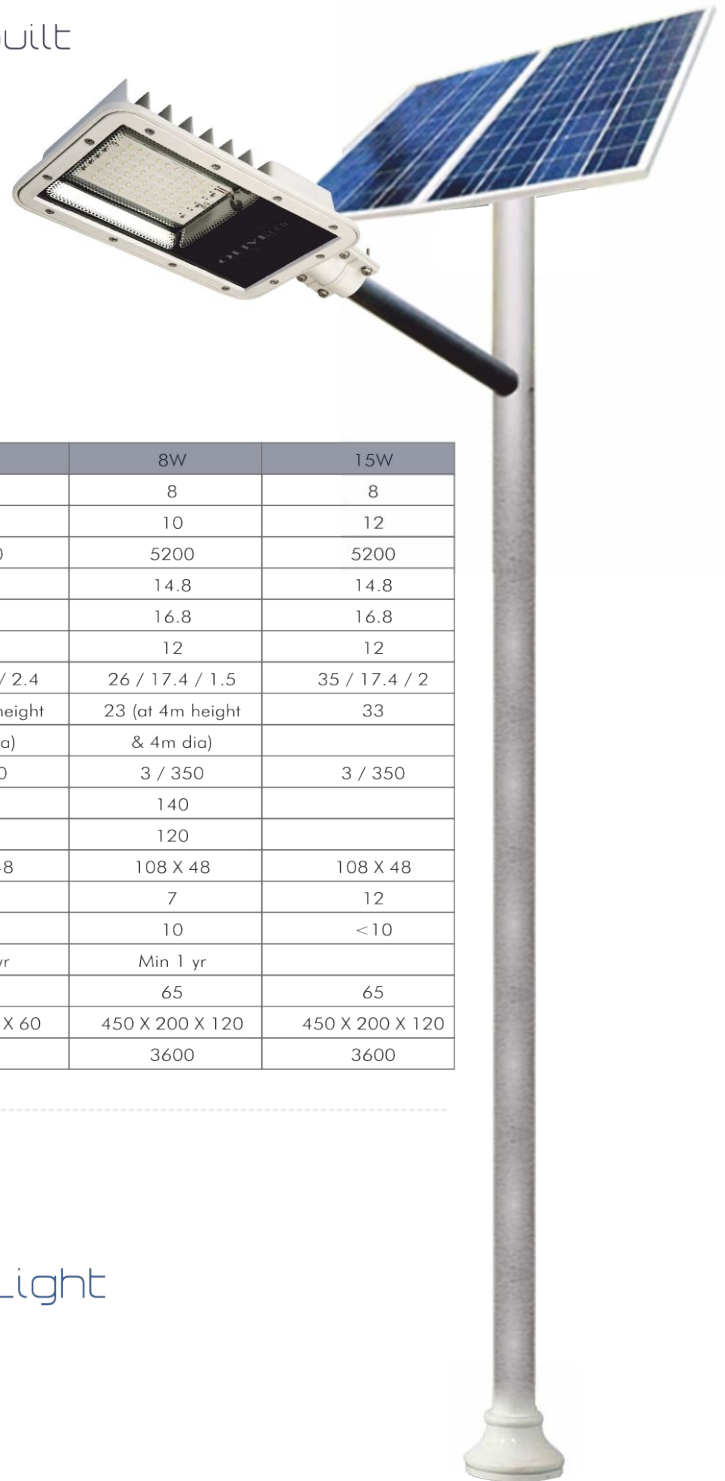

Standalone (Built in Batteries) Street Light System- SunWay

TECHNICAL SPECIFICATIONS

Parameter	Units	4W	8W	15W
Solar Charging – full sunlight	hrs	8	8	8
Run time (min.)	hrs	10	10	12
Battery Capacity	mAh	10400	5200	5200
Battery nominal voltage	V	3.7	14.8	14.8
Battery upper cutoff voltage (after stabilization)	V	4.25	16.8	16.8
Battery lower cutoff voltage (after stabilization)	V	3	12	12
Solar Panel Pm / Vm / Im	Wp / V / I	14 / 5.88 / 2.4	26 / 17.4 / 1.5	35 / 17.4 / 2
Light output (Avg)	Lux	12 (at 4m height & 4m dia)	23 (at 4m height & 4m dia)	33
LED Forward Voltage / Current	V / mA	3 / 350	3 / 350	3 / 350
LED Luminous Intensity	Lumen	140	140	
LED Directivity	degree (2θ/2)	120	120	
Lens FWHM angle	degree	108 X 48	108 X 48	108 X 48
Power Consumption	W	4	7	12
Idle current	μA	10	10	<10
Battery lifetime	Yrs	Min 1 yr	Min 1 yr	
IP		65	65	65
Dimension (l×w×h)	mm	380 X 135 X 60	450 X 200 X 120	450 X 200 X 120
Weight (light only)	gms	1780	3600	3600



LED Solar Street Light

Product No : Solar Street Light

Power	6, 9, 12, 18, 24, 30, 36, 45 Watts
Input Voltage	12V DC
CCT	2800K-6500K (Optional)
CRI	>80Ra
Angle/Optics	180°
LED Lumens	145/watts
Mounting	Pole Mounting
Charge Controller	Internal/External (Optional)

For More Details Please refer Product Specifications Online





Some of Our Esteemed Clients

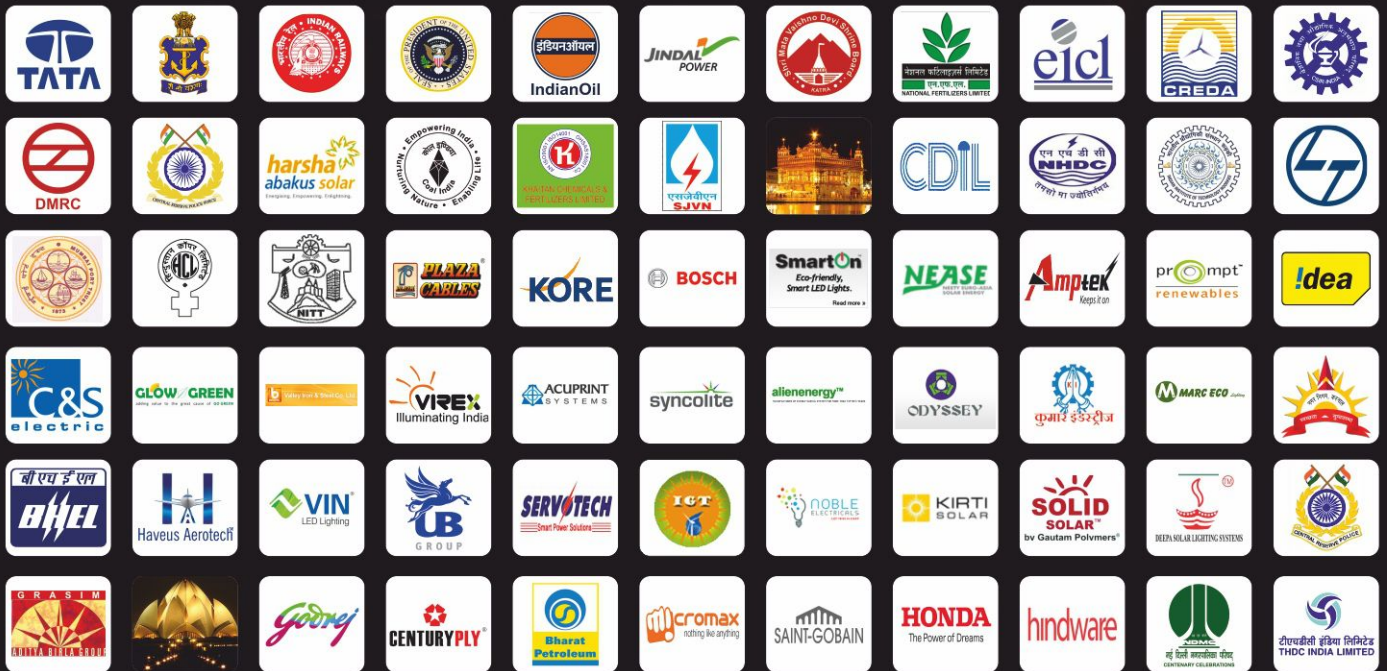

and many more....

- * APPROVED VENDOR FOR NTPC, BHEL, BPCL, MUMBAI PORT TRUST, SMVDSB, ITI, DMRC, IIT, DMRC, SE COALFIELD, CRPF, RAILWAYS, EMBASSY OF UNITED STATE OF AMERICA, HCL, BAHAI HOUSE (LOTUS TEMPLE), GOLDEN TEMPLE, DOORDARASHAN/PRASAR BHARTI, NFL, HCL, THDC, NHDC, MARUTI, AND MANY MORE GOVERNMENT DEPARTMENTS.
- * SOME OF OUR CLIENTS IN CORPORATE WORLD : GODREJ, JINDAL POWER LTD, BGR ENERGY, KHAITAN, DD MOTORS, JP, L&T AND MANY MORE



Recognition & Credentials



and many more....

Patent Encroachment

Copying of any of the patented products in whatsoever manner will be considered illegal and lawsuit will be filled against the offender. We also manufacture baspoken LED lights as per clients' specifications.



Olive Exports Pvt. Ltd.

Office : 3870A/10, Kanhaiya Nagar, Opp. Metro Pillar No. 230, Delhi-110035 (INDIA)
Phone : 091 11 2738 6560, +91 9311855999, +91 931134999
Fact. Del. : O-14, Sector -3, DSIIIDC Indl. Area, Bawana, Delhi-110039
Fact. Hr. : Plot # 40, Sec.-7, IMT Manesar, Gurgaon, Haryana
e-mail : s.jindal@oliveled.in; support@oliveled.in
Website : www.oliveled.in, www.oliveledlights.net, www.ledstreetlight.in,
www.oliveled.tradeindia.com, www.indiamart.com/oliveled

